

**Archimedes**

# WELCOME GUIDE



**Acorn**   
The choice of experience.

Copyright © Acorn Computers Limited 1988

Neither the whole nor any part of the information contained in, nor the product described in this Guide may be adapted or reproduced in any material form except with the prior written approval of Acorn Computers Limited.

The products described in this manual are subject to continuous development and improvement. All information of a technical nature and particulars of the products and their use (including the information and particulars in this Guide) are given by Acorn Computers Limited in good faith. However, Acorn Computers Limited cannot accept any liability for any loss or damage arising from the use of any information or particulars in this manual, or any incorrect use of the products. All maintenance and service on the products must be carried out by Acorn Computers' authorised dealers. Acorn Computers Limited can accept no liability whatsoever for any loss or damage caused by service, maintenance or repair by unauthorised personnel.

All correspondence should be addressed to:

Customer Support and Service  
Acorn Computers Limited  
Fulbourn Road  
Cherry Hinton  
Cambridge CB1 4JN

Information can also be obtained from the Acorn Support Information Database (SID). This is a direct dial viewdata system available to registered SID users. Initially, access SID on Cambridge (0223) 243642: this will allow you to inspect the system and use a response frame for registration.

ACORN, ARCHIMEDES and ECONET are trademarks of Acorn Computers Limited.

Within this publication, the term 'BBC' is used as an abbreviation for 'British Broadcasting Corporation'.

Edition 2  
First published 1988  
Published by Acorn Computers Limited  
ISBN 1 85250 055 7  
Part number 0483,000  
Issue 1

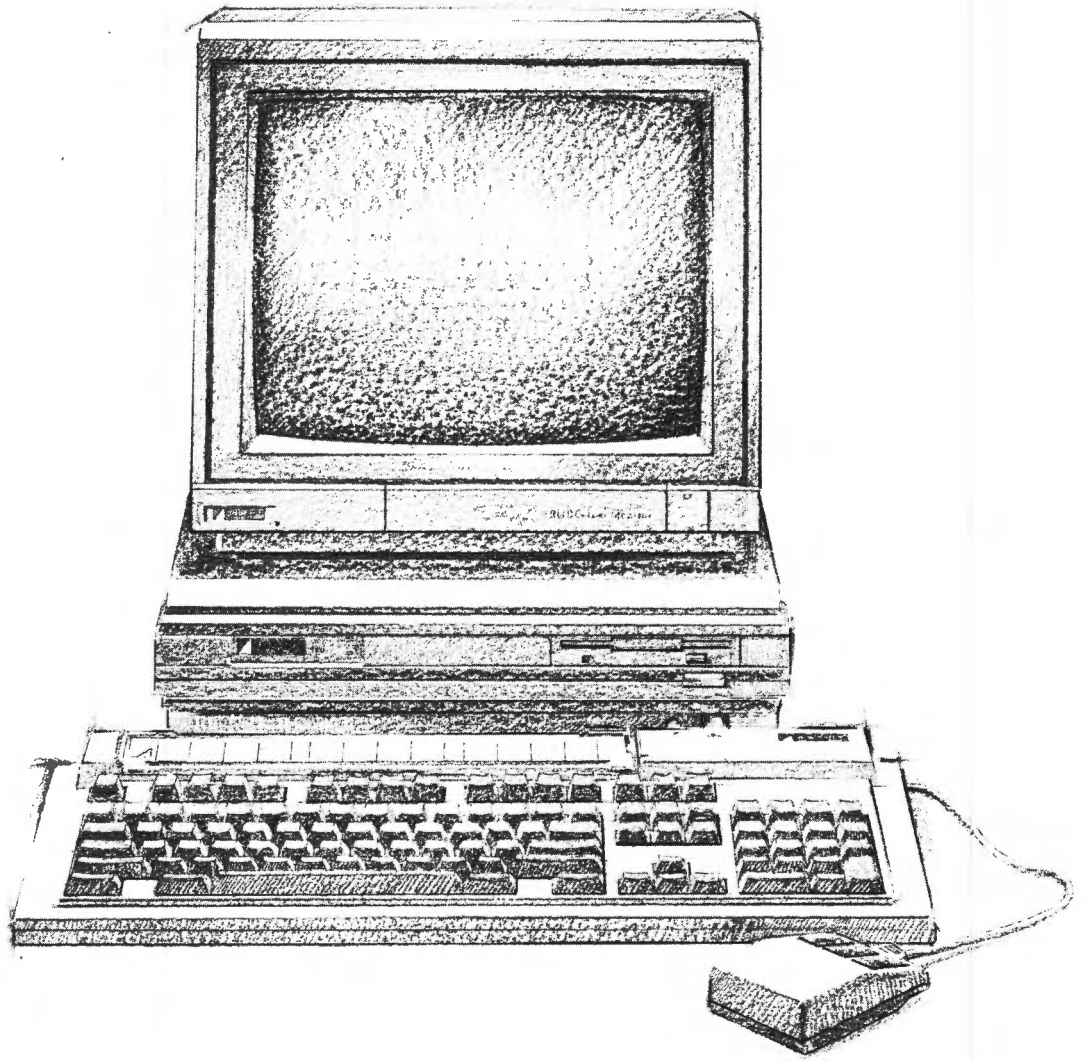

## Welcome to the Archimedes personal workstation

This guide introduces your new Archimedes personal workstation. It explains how to connect it together and how to start using it.

It doesn't matter if you've never used a computer before - the Archimedes system is easy to use, and you need learn only a few simple techniques and terms to get going. You can pick up the details as you go along.

Once you've set up the system and mastered the techniques described in this guide, the *User Guide* will help you to get the best out of your Archimedes system and answer many other questions you may have.

# About this Guide

This Guide is an introduction to the Archimedes personal workstation for the first-time user, and is divided into the following chapters:

<b>Unpacking</b>	Describes the parts which make up the Archimedes computer. Check the contents of the box to make sure you have everything.	<b>5</b>
<b>Setting up the computer</b>	Explains how to connect everything together.	<b>7</b>
<b>Getting started</b>	Tells you how to turn the computer on and describes the display on the screen.	<b>11</b>
<b>The Archimedes desktop</b>	Introduces the <i>desktop</i> facilities, explained in greater detail in later chapters.	<b>13</b>
<b>Using the mouse</b>	Describes what the mouse does and how you use it.	<b>17</b>
<b>Disc drives</b>	Tells you about the floppy and hard discs used with Archimedes computers.	<b>23</b>
<b>Windows</b>	Explains the special features of the screen display.	<b>27</b>
<b>Menus</b>	Explains how to select items from lists ( <i>menus</i> ) displayed on the screen.	<b>37</b>
<b>Using the keyboard</b>	Introduces the keyboard and some of its features.	<b>41</b>
<b>Files &amp; directories</b>	Introduces the Archimedes desktop filing system.	<b>45</b>
<b>Outside the desktop</b>	Tells you how to enter <i>*commands</i> direct to the <i>operating system</i> (this chapter will be of interest to computer users with some experience).	<b>51</b>
<b>If things go wrong</b>	Offers solutions to some common problems you might encounter.	<b>53</b>
<b>Glossary</b>	Lists computer jargon used in the Welcome Guide and explains its meaning. Each term in the Glossary is highlighted in <i>italics</i> the first time it is used in the text.  If you want to know more about any particular part of the Archimedes system, turn to the <i>User Guide</i> .	<b>55</b>

# Unpacking

*This section tells you about unpacking your Archimedes system, lists the items which should be in the box when you receive it, and helps you choose a spot where you can set it up.*

## Unpacking

Unpack your Archimedes system on a flat surface - a large table where there's plenty of room for the box as well as for the computer is best. Take all the pieces out of the box, making sure you don't break the foam packing material, as you may need this later.

## Checklist

Check that you have all these components, and that they've arrived in good condition:

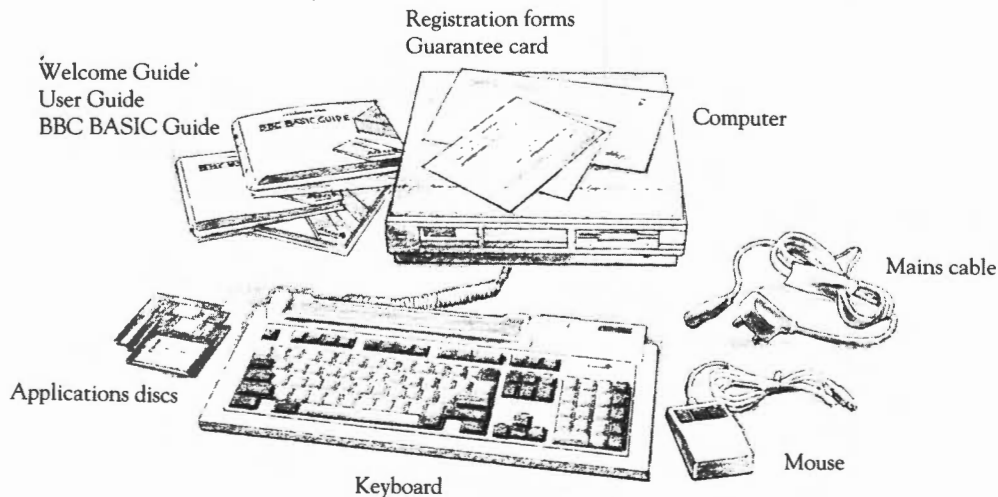

You'll probably have bought a *monitor* (with mains lead) and connecting cable at the same time.

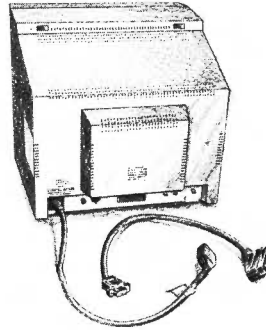

If you don't have all of these parts, or if any of them is damaged, notify your supplier immediately.

Fill in the registration form and post it back to Acorn Computers, so that you can be informed of developments and updates to your Archimedes computer. This will help us to ensure that you get the best from your computer in the future.

Put all the packing back into the box and put it away somewhere safe. If you ever want to transport your Archimedes system, it is best to use the box, even if you only take it a short distance in a car. If you ever have to take it back to your dealer, too, you'll have to pack it back into the original box.

### **Choosing where to put your computer**

You'll probably want to put your computer on a table or a desk. Bear the following points in mind when deciding exactly where to situate it:

- you'll need a firm, flat surface with enough space at one side to move the mouse around, and space at the other side for manuals and papers you may be working on.
- don't place the computer where it will be exposed to direct sunlight, or any other source of heat, such as a radiator.
- if you have any *peripheral* equipment (such as a printer) you'll need space nearby for that too.
- sunlight or reflections from a window might make the screen difficult to see.

There must also be an accessible 13 amp power point within 1.5 metres of the computer.

# Setting up the computer

*This chapter describes how to connect the components of the computer together and set it up ready for use. Before you start connecting it up, please read the Guidelines for safe operation in the front of the User Guide.*

After you've checked the components against the checklist in the last section, you can connect them together and begin to use your Archimedes computer.

Follow these simple steps to set up your computer:

## 1. Connect mouse to keyboard

Take the mouse and the keyboard out of their plastic bags. The mouse has a straight cable with a plug on the end of it. This goes into the socket at the back of the keyboard. The plug has an arrow moulded into it. This should be uppermost when you push it in. The plug won't go in any other way, so don't try to force it in.

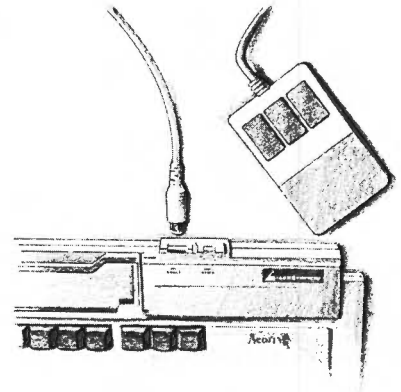

## 2. Connect keyboard to computer

The keyboard has a curly cable with a plug on the end of it. Plug this into the socket on the front right hand side of the computer unit (just below the disc drive slot), with the arrow uppermost: don't force it. Place the keyboard in front of the computer.

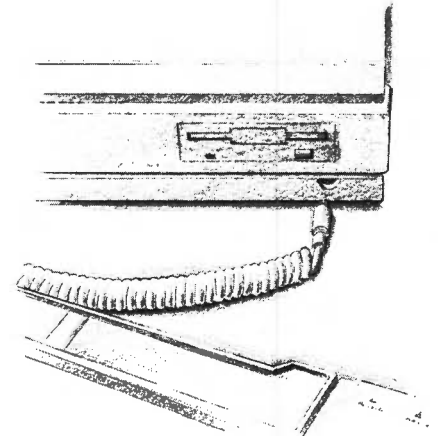



### 3. Connect monitor to computer

#### Colour monitors

Put the monitor on top of the computer (unless it weighs 15 kg or more, like the 19-inch high-resolution monitor which can be used for 400-series machines, in which case it will have to go alongside, or on a strong shelf above).

If you have a colour monitor, it will have a cable with different connectors at either end.

Push the big plug into the back of the monitor, and the small plug into the socket on the back of the computer marked ANALOGUE RGB. Both plugs and sockets are wider at the top than at the bottom, so it isn't possible to put them in the wrong way up. Secure the connector to the computer with a small flat-bladed screwdriver.

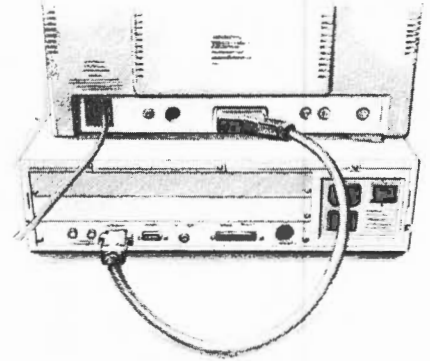

#### Standard-resolution monochrome

If you have a standard-resolution monochrome monitor for a 300-series machine, it will have a cable with round plugs on either end. Push one plug into the socket on the back of the computer unit marked MONO VIDEO, and the other into the socket marked VIDEO IN on the back of the monitor.

Note - if you want to connect anything else to your computer (like a monochrome monitor to a 400-series machine, a printer or Eiconet network), go to the end of this chapter now.

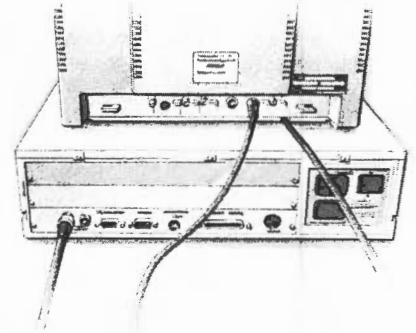

#### 4. Connect mains supply

If your monitor has an IEC-type mains plug, plug this into the socket marked UNSWITCHED O/P 220-240V on the back of the computer. If it has a normal mains plug, plug this directly into the mains.

Finally, plug the connector on the mains cable into the socket marked I/P 220-240V on the back of the computer unit.

Check that the computer is switched off (see the next chapter). Connect the plug to the mains and switch the mains on.

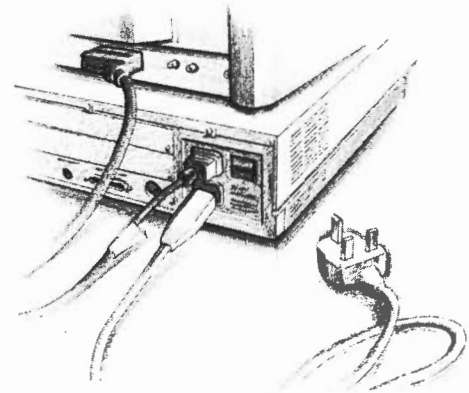
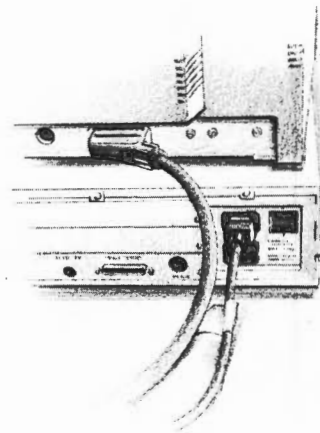

#### Connecting other things

##### Alternative monitors

Connect a *high-resolution* monochrome monitor to a 400-series machine with two leads (having BNC twist-lock connectors at either end) connected to the sockets marked VIDEO and SYNC on the back of the computer.

If you want to connect a *standard-resolution* monochrome monitor to a 400-series machine, some internal adjustments to your computer will be necessary consult your supplier for advice.

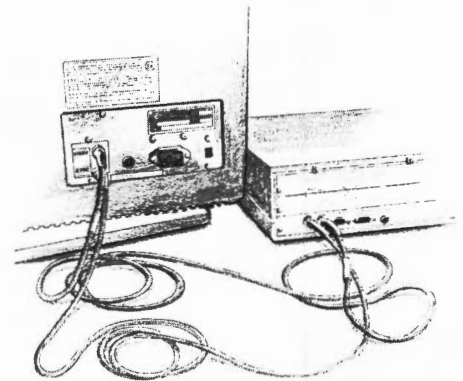

## Peripherals

*Peripherals* should also be connected to the computer *before* the power is switched on:

- If you have a parallel printer, connect it to the socket at the back of the computer marked PARALLEL PRINTER. Connect a *modem* or a serial printer to the socket marked SERIAL PORT.
- If you have an *Econet* network, connect your Archimedes computer to the network using the socket marked ECONET. You will also need to install an Econet module inside the computer (instructions on installing it come with the module).

To continue connecting up your Archimedes system, go back to step 4 now.

# Getting started

*This chapter tells you how to switch on the computer and what you see on the screen when you do.*

## 1. Equipment check

First check that all parts of the computer have been properly connected together, as described in the previous chapter.

## 2. Switch on the monitor

The monitor has a separate switch. The manual for your monitor will explain how to turn it on and, if necessary, adjust the brightness control.

## 3. Switch on the computer

Press the rocker switch on the back of the computer:

O is Off

I is On

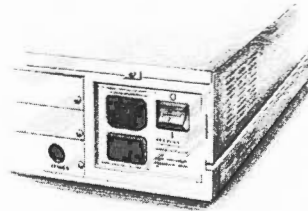

The Archimedes *desktop* will appear on the screen, looking something like this:

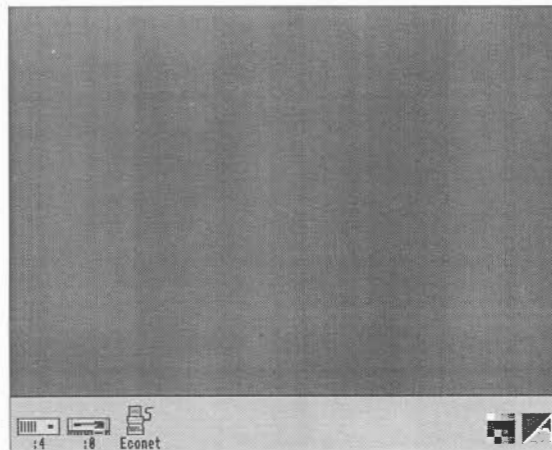

## Introducing icons

The little pictures in the lower margin of the screen represent the facilities available. They are called *icons*. The area they occupy is the *icon bar*. Icons are described in the next section.



## The pointer

The arrow on the screen is the *pointer*. It is used to indicate items you want to use or move.



The pointer moves around the screen as you move the mouse. The mouse moves best over a firm, flat surface. Try moving the mouse to see how the pointer moves.

As soon as the desktop has appeared on the screen, you can begin working. It is better, though, to read the next section, which explains briefly the principles of the Archimedes desktop and its components.

# The Archimedes desktop

*This section describes the appearance of the desktop, the principles of the window system and how to use the desktop features.*

## The desktop

When you first switch on the computer, the desktop is normally displayed on the screen. This is your working area. At first it is clear, except for the icon bar. As you perform tasks and use applications, items will be added to the desktop. You can move them around the desktop as you wish, change their size, hide and remove them to make room for others.

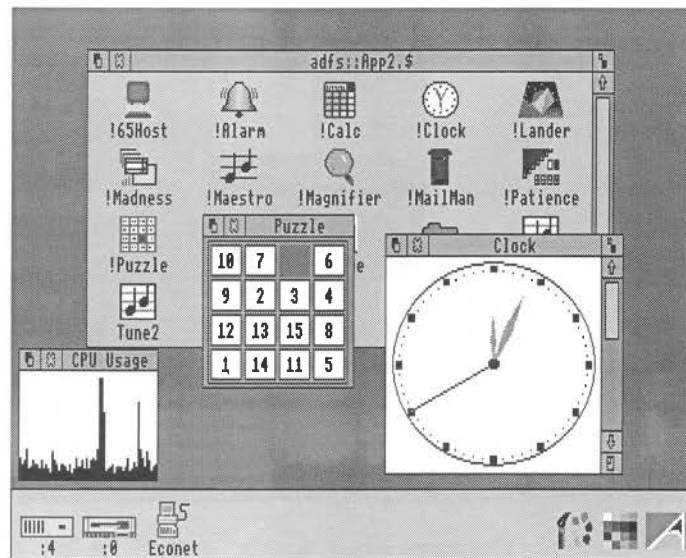

The Archimedes desktop and windows system is easy to use because you don't have to remember long, complicated commands. When you see what you want you just point at it, using the mouse, and select it.

The important features of the Archimedes desktop system are windows, icons, the mouse and menus.

## Windows

A window is an area of the screen allocated for a special function. In a window you can show a list of the *files* on a disc, write a memo or a program, draw a picture, alter the colours used for the screen display or perform other types of task. You can have several windows open on the screen at once, and you can even be doing something different in each of them at the same time. Windows are described further in the section *Using windows*.

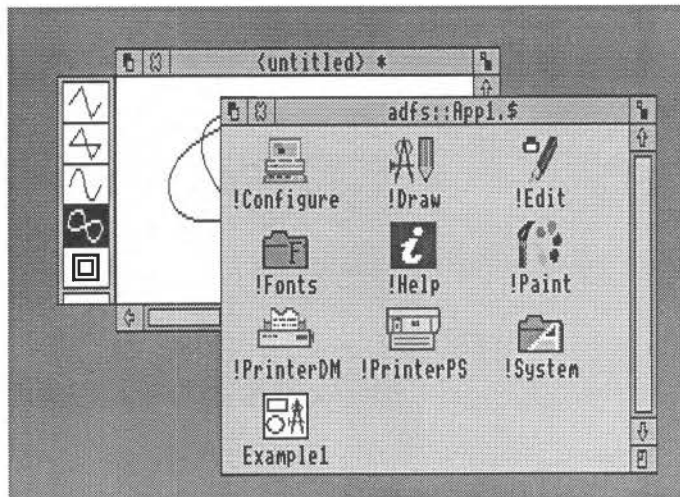

## Icons

The icons which appear on the icon bar represent things available for use on the desktop. If you want to do something, or examine the contents of a filing system, you look at the icon bar to see if its icon is available. If it is, you can select it and a window containing the activity you want is opened.

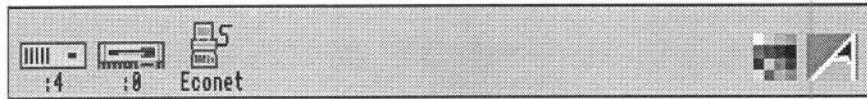

The icons on the left of the icon bar represent the information storage facilities - that is, the discs and other places where you can load information from, and save it to. At least one will appear on the icon bar:



**Floppy disc drive.** The Archimedes computer uses 3.5 inch floppy discs, loaded into the drive slot on the front panel. You can save (store) information by copying it from the computer's memory onto a floppy disc, and retrieve it later by loading it back into the computer from the disc. Floppy discs are described in the chapter *Disc drives*.

There may also be:



**Hard disc.** If you have a hard disc, a hard disc icon will also appear in the lower left hand corner.



**Econet.** If your computer is fitted with a card for an Econet local area network, there will also be an Econet icon.

On the right hand side are the *applications* icons. These represent things you can do, such as word-processing and drawing programs. Initially only two are loaded:



**Palette.** This enables you to change the colours or grey scales on the screen, depending on your monitor type.



**Task manager.** This enables you to switch from the desktop to the *operating system* and other tasks, and to look at and control the allocation of your computer's memory (more information on this is given in the chapter *Outside the desktop* - it will be of interest to experienced users.)



## The mouse and pointer

The mouse moves the pointer around the screen. The buttons on the mouse are used to select or adjust items you are pointing at on the screen, or to display menus. Using the mouse is explained in the next chapter.

## Menus

A menu is a list of tasks or other options from which you can choose what you want to do next. Menus are an easy way of making a selection - you don't usually have to type anything, you just point at what you want, then select it. See the chapter *Menus* for more details.

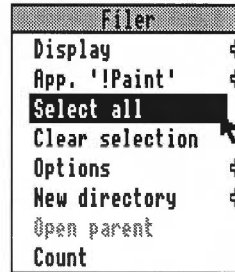

# Using the mouse

*This chapter tells you how to hold and move the mouse, and how to carry out the different mouse techniques used in the desktop. If you have any difficulties making it work, turn to the chapter "If things go wrong".*

## **Holding the mouse**

The mouse is used to select, move and adjust items displayed on the screen. It is your principal means of communicating with the Archimedes desktop.

As you move the mouse, the pointer on the screen moves correspondingly. Try it and see:

Hold the mouse with the cable away from you so that your fingers rest easily on the three buttons. If you are right-handed, you should hold it like this:

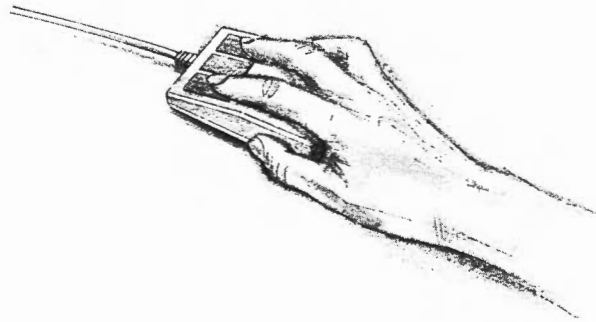

Move the mouse around and watch the pointer move around the screen. If you run out of space to move the mouse, lift it up and put it down again in a more convenient spot. While the mouse is lifted, the pointer will not move, and when you put it down again you can carry on where you left off.

## The mouse buttons

The mouse has three buttons, known as **select**, **menu** and **adjust**:

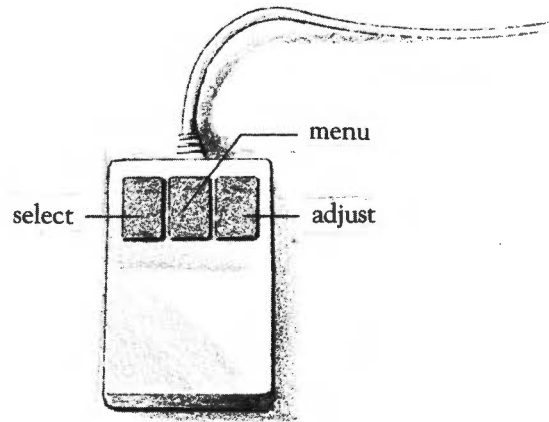

The **select** button is used most of the time to select icons displayed on the screen.

Pressing the **menu** button usually makes a menu appear. Menus are described in the chapter *Menus*.

The **adjust** button is not often used - the *Menus* chapter includes one instance. Try using the select button first when you want to alter something.

## Mouse techniques

Normally, you press the mouse button just once and then release it immediately. This is called *clicking*.

Two other mouse techniques are also used:

*double-clicking* - pressing and releasing twice in quick succession. This is used to initiate an action, or to load an application, for example.

*dragging* - to move an icon from one place to another.

Clicking and dragging techniques are summarised on the next page.

## Clicking

### 1. Point at the icon

Move the mouse so that the pointer is over the item you want to select.

*For example, point at the desktop colour palette icon on the icon bar.*



### 2. Click on the mouse

Click once on the left hand button of the mouse.

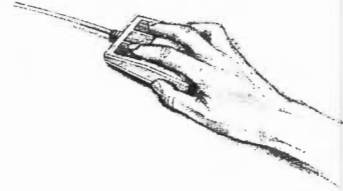

### 3. The item will be selected

*The palette will appear on the screen.*

## Dragging

### 1. Point at the icon

Move the mouse so that the pointer is over the item you want to move.

*For example, point at the title bar along the top of the palette window.*

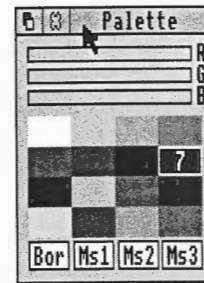

### 2. Select it with the mouse

Press and hold down the left button of the mouse:

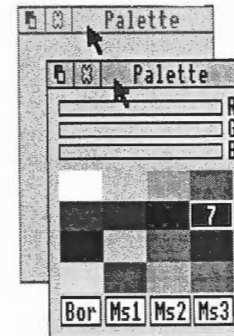

### 3. Move the mouse and drag the icon

Move the mouse to drag the object across the screen. Release the mouse button when it is where you want it to be.

## More practice with the mouse

One of the icons on the icon bar is the palette, mentioned in the mouse techniques procedures. This lets you alter the colours used in the screen display. Click on the palette icon to display the palette on the screen:

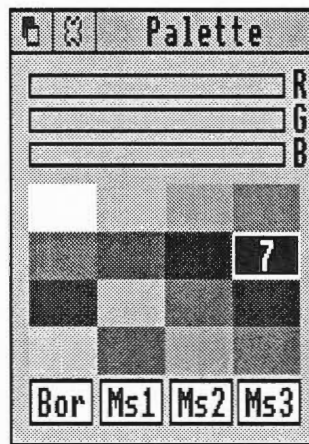

Now click on the third colour block on the top row. The colour block is outlined, and the number 2 appears in it:

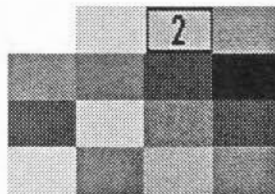

Colour number 2 is used to display the title bar along the top of the window.

The bars at the top of the colour selection panel will have changed to show the proportions of red, green and blue which make up that colour. You can adjust the colour of the title bar by either dragging or clicking anywhere in the colour bars.

Move the pointer somewhere in the middle colour bar, and press the left mouse button. The bar will snap to the position of the pointer, and the colour will change accordingly. Keep the button down, and **drag** the bar backwards and forwards. Notice how the colour at the top of the window changes as you do this - it works rather like a slider volume control on a stereo. By moving the bar, you're adjusting the proportions of green in the colour of the title bar.



Try dragging the other bars, too, to see how different proportions of blue and red change the colour of the title bar.

When you have practised this a bit, click on the cross in the top left of the window. The palette disappears, but the new colour definitions are still used until you change the colours again or switch off the computer.

That's clicking and dragging. If you want to know more about the colour palette itself, see the *User Guide*.



# Disc drives

*This chapter tells you how to use and take care of your Archimedes discs and drives.*

## **Floppy discs and hard discs**

Information and programs are stored on discs. There are two types of disc floppy discs and hard discs.

The Archimedes personal workstation uses 3.5-inch floppy discs, which are loaded into the computer as they are needed.

A hard disc is much faster and holds a lot more information than a floppy disc, and is built into the computer. If your Archimedes model has a hard disc, its presence is indicated by an amber light labelled H/DISC on the front panel of the computer.

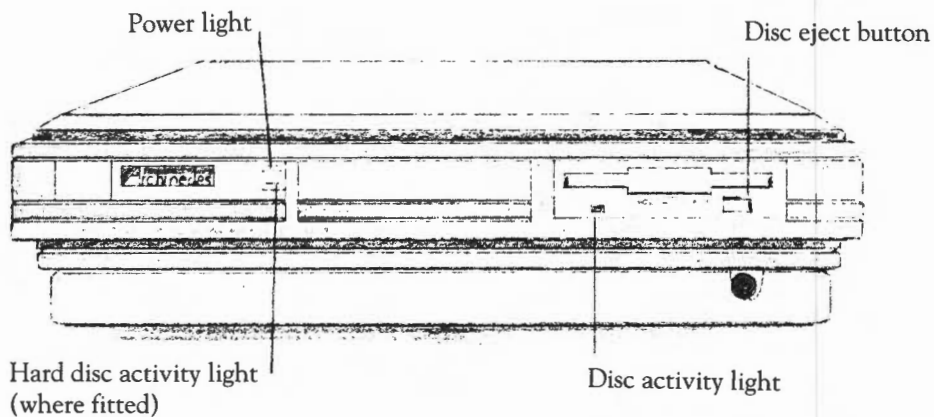



## Inserting floppy discs

The floppy disc drive is the slot to the right of the computer unit. Insert discs like this, with the label uppermost:

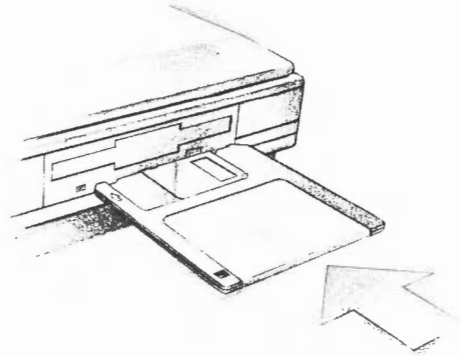

The disc clicks into place when it is fully inserted. Practise inserting one of the Applications discs.

## Ejecting floppy discs

To eject a floppy disc from the computer, press the button below the disc slot, but not if the yellow activity light is on, indicating that the drive is still running.

## The Applications suite

Your Archimedes computer is supplied with an Applications suite on floppy discs, which contain application programs, utilities and games.

It is advisable to make back-up copies of the discs before you use them, just in case you delete something by mistake. The chapter *The Advanced Disc Filing System* in the *User Guide* tells you how to make back-ups.

Archimedes machines with hard discs are delivered with the Applications suite on the hard disc.

## Accessing information on discs

To gain access to the information contained on a floppy disc which has been inserted into the drive, or on a hard disc, click on the appropriate disc drive icon on the icon bar:



The contents of the disc will be displayed in a window for you to see:

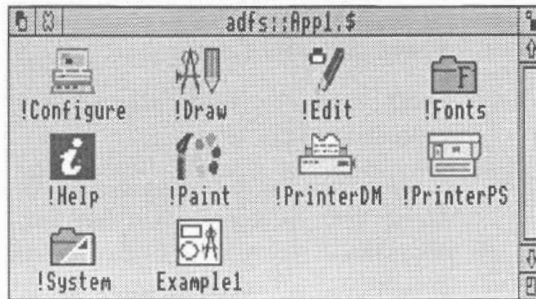

### Write-protecting floppy discs

The Applications discs are supplied *write-protected*. This means that you cannot change anything on the disc, delete anything by mistake, or save any new files to the disc.

You write-protect a new disc by moving the plastic tab with your finger nail towards the outside edge of the disc:

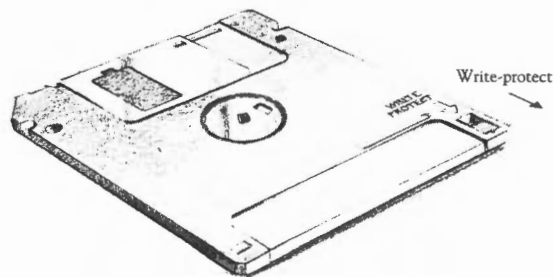

## Looking after floppy discs

You will build up a collection of discs as time passes. Label them so that you always know which one holds the information you need. Store them carefully and keep them away from:

- extremes of temperature
- strong magnetic fields
- dust, dirt, coffee, pets etc.

Don't open the metal shutter on the disc, as the disc surface is easily contaminated by dust.

## Looking after hard discs

If your Archimedes computer is fitted with a hard disc, you'll have less floppy discs to worry about, but you should take some additional precautions, as follows:

- Never move the computer, or press Break or Reset, whilst the H/DISC activity light is illuminated.
- If you have a 20MB hard disc, when you have finished your session, and before you switch off, click on **Dismount** on the hard disc icon menu (see *Menus*). This 'parks' the hard disc, and prevents damage being done to the disc while it is switched off. You must make sure you do this before you move an Archimedes computer fitted with a hard disc. Larger capacity discs carry out this task automatically.

# Windows

This chapter describes windows and explains how they can be moved, resized, hidden and closed. It describes how to move through the contents of a document too large to display in a window all at once.

## What is a window?

A *window* is an area of the screen displaying an activity or application. Examples of windows you have seen so far are the colour selection palette and the directory window, displayed when you click on the palette and disc drive icons respectively.

## Features of windows

Most windows can be moved around the screen, hidden behind other windows, or closed completely. Icons on the windows allow you to do these things. Some windows also have icons which allow you to change their size.

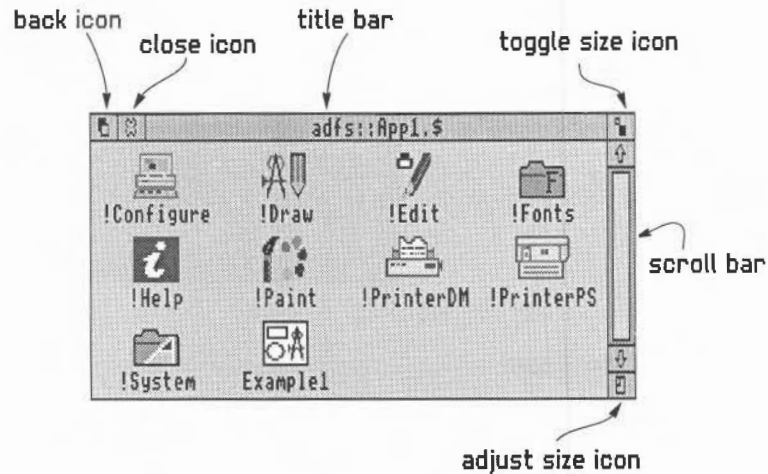

Title bar

Displays the title of the window. This may be the name of an application, or the name of a document if you are editing text.



Back icon

If you click on this, the window will be hidden behind any windows which overlap the area it occupies. The effect is that of putting the window to the back of the 'pile' of windows on the screen.



Close icon

Clicking on the Close icon closes the window, removing it from the screen.



Toggle size icon

This icon switches the window between full size and the last size displayed. (Full size is either large enough to display the complete document, or so that the window fills the screen. This alternating action is called *toggleing*.)



Adjust size icon

The Adjust size icon lets you drag the icon to alter the size and shape of the window.

### Displaying some windows

Put Applications disc 1 into the disc drive and then click on the disc drive icon to display the *directory* window. The directory window shows the contents of the disc:

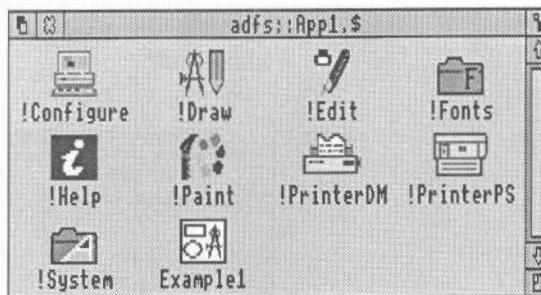

Click on the palette icon to bring the palette window up onto the screen as well.

### Practising manipulating windows

Practise using the window icons to do the things described on the following pages.

## Dragging a window

1. Select the title bar

Move the pointer onto the title bar and press the select (LH) button.

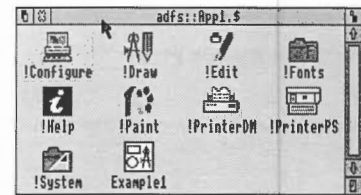

2. Move the mouse

Keep the button pressed, and drag the window.

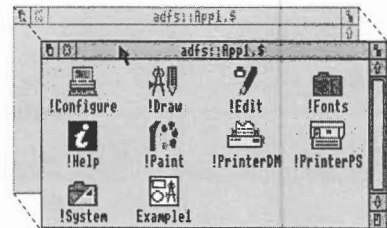

3. Release the mouse button

Release the button when the window is where you want it to be.

## Resizing a window

1. Select the window size icon

Move the pointer to the window size icon and press the select (LH) button.

*Practise this on the Applications disc directory window.*

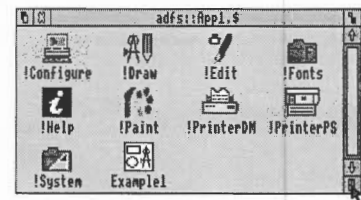

2. Drag the icon

Keep the button pressed, and drag the icon to change the size of the window.

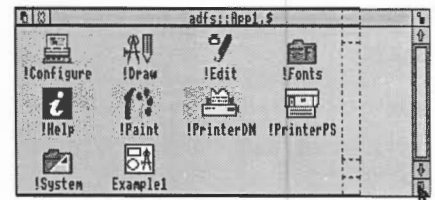

3. Release the button

Release the button when the window is the size you want it.

## Toggling window size

1. Select the toggle size icon

Move the pointer over the toggle size icon and click the select (LH) button.

*Practise this on the Applications disc directory window.*

The window size will snap to nearly the width of the screen.

Clicking on the icon again will reverse the process.

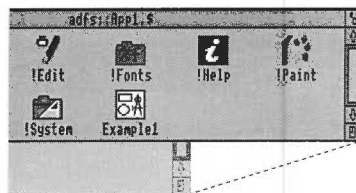
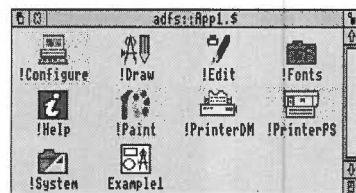

## Shuffling windows

When you have a pile of windows on the screen, you can get at the one you want by sending windows to the back and bringing them to the front:

*If they are not already overlapping, drag one of the windows on top of the other to practise this.*

Bringing a window to the front

Click on the title bar to bring a window to the front.

Sending a window to the back

Click on the back icon to send a window to the back.

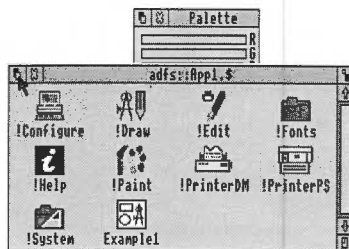
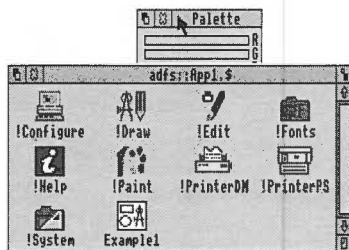

## Closing windows

### 1. Select the close icon

Position the pointer on the close icon and click the select (LH) button.

*For example, close the directory window.*

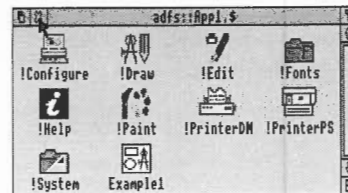

The window will disappear from the screen.

If the window has some unsaved work in it (some edits you have made to a document for example), you will be asked whether you want to save the changes you made since you last saved it.



## Scrolling

A window is so named because it often acts as a window through which you can view something which may be much bigger. It allows you to see an area of a file, directory or picture stored in the computer. The proportion of the file visible depends on the size and shape of the frame. The area of the file you can see alters as you move the frame around:

A window onto  
an area of a  
document

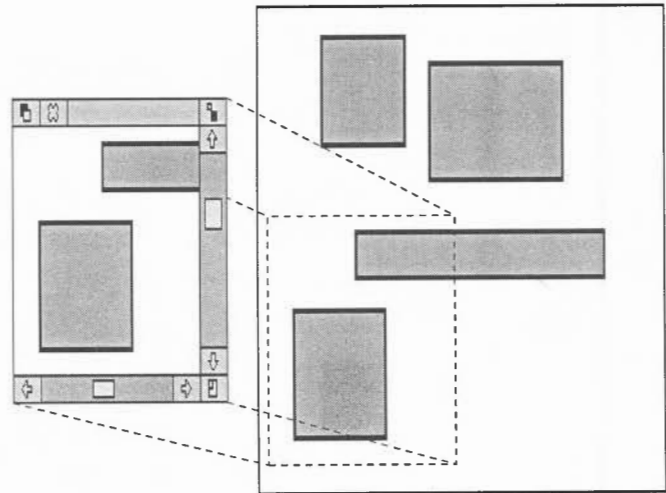

The technique of moving the window around a large file is called *scrolling*.

Most windows have *scroll bars* and *scroll arrows* to enable you to move the window around a file:

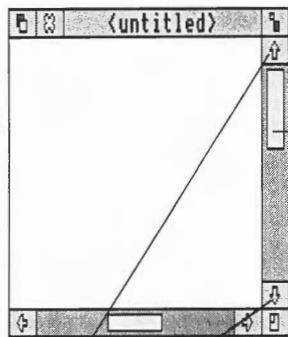

### Scroll bars

allow you to scroll the window over the document (or directory or picture) you are viewing.

The size of the **slider** shows what proportion of the document is visible. (If the slider occupies half of the length of the scroll bar, half the document is visible.) To display a different area of the document, drag the slider along the scroll bar.

### Scroll arrows

are at each end of the scroll bar. Click on the arrow showing the direction you want to move in - left, right, up or down.

## Practising scrolling

To load a file on which you can practise scrolling, put the disc Applications 2 in the drive and click on the floppy disc drive icon. When the directory is displayed, double-click on the Tune1 icon, and a piece of music will appear in a window with scroll bars.

Practise the scrolling techniques shown on the next two pages:

## Scrolling line by line

### 1. Select the scroll arrow

Position the pointer on the scroll arrow and click on the select (LH) button to scroll one line.

Hold the button down to continue scrolling.

Click on the adjust (RH) button to scroll back the other way.

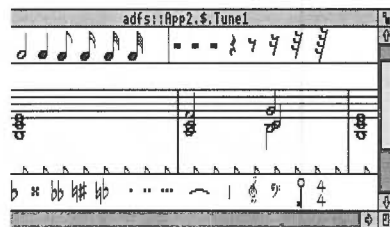

Scroll left or right, column by column, the same way (on windows which have horizontal scroll bars).

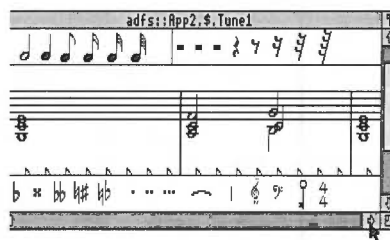

## Scrolling screen by screen

### 1. Select the shaded part of the scroll bar

Position the pointer on the shaded part of the scroll bar (above the slider to scroll up, below the slider to scroll down), and click on the select (LH) button.

The next windowful of the document will appear.

Click on the adjust (RH) button to scroll back the other way.

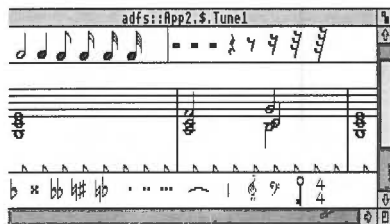

## Moving through a file

### 1. Select the slider

Position the pointer on the slider, press the select (LH) button *and keep it pressed down*.

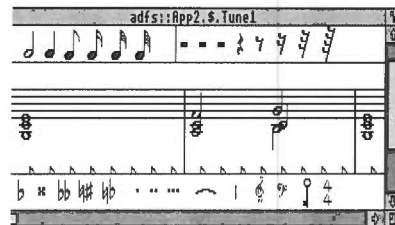

### 2. Drag the slider

Drag the slider to display the part of the file you want to view.

Move from one *side* of a document to the other by using the horizontal scroll bars (if the window has them).

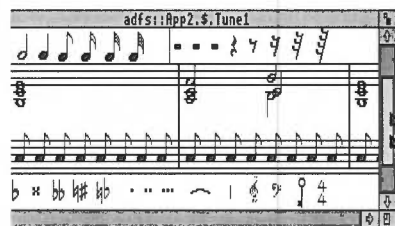



# Menus

*This chapter tells you what menus are, how to display them and choose things from them, and how to type in answers when the computer asks you to be more specific about what you want.*

## What is a menu?

A menu in computer jargon is similar to a menu in a restaurant - it's a list of things to choose from. Instead of having to remember what you can have, and how to ask for it, you just point at what you want on the menu and select it. This is the main way of doing things in the Archimedes desktop.

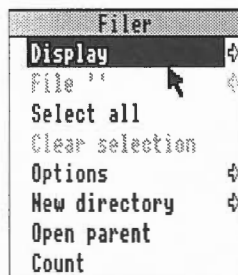

## Using menus

Click the middle mouse button to display a menu. The menu displayed will depend on where the pointer is on the screen at the time, whether the icon has been selected, and also on what you are doing at the time.

Use the directory window of Applications disc 1 to practise displaying menus.

Practise the menu techniques described on the following pages.

## Displaying a menu

1. Point to the relevant icon

Move the pointer over the window or icon you want to work on.

*For example, move the pointer over the Applications disc 1 directory window.*

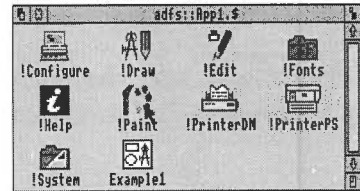

2. Click on the middle mouse button

The menu will be displayed.

Note that the menu will change to apply to an individual file in a directory window, if the pointer is over the file name, or if you have previously selected its icon by clicking on it.

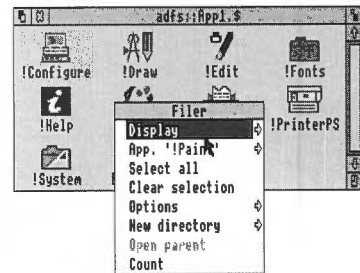

## Choosing from a menu

1. Select the menu item you want

Move the pointer over the menu item you want and click the select (LH) button.

The action requested will occur.

*For example, point at the **Select all** option on the Filer menu and click select.*

*The file icons in the directory window will all be highlighted. Repeat the process, choosing **Clear selection** to reverse it.*

Use the adjust (RH) button if you want the menu to stay on the screen - otherwise it will disappear when you press the button.

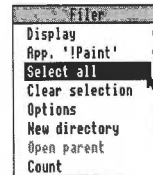

## Choosing from a sub menu

1. Select the main menu item
2. Display the sub menu item
3. Select the sub menu item

Move the pointer onto a main menu item with an arrow. The arrow indicates sub menus are available.

*For example, point at the Display option on the Filer menu.*

Move the pointer in the direction of the arrow.

*The Display sub menu will appear on the screen.*

Highlight and select your sub menu choice, by clicking on it.

*Select Small icons. The file icons in the directory will change size.*

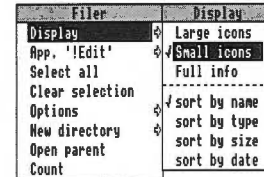

## Writable menu boxes

1. Type in the information requested
2. Click on the name

Some menus include *writable menu boxes*. That is to say, they invite you to type in information, such as a file name. Some boxes are blank, while others include a *default* name, which you can change if you want to. You can use the Delete key to erase the original name.



In this case you have to type in the name of the *file* you want. The text will appear to the left of the vertical bar (called the *caret*).

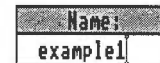

Use the Delete key to erase mistakes.

When you are happy with your entry, click on the name.

The action requested will be carried out.





# Using the keyboard

*This chapter describes the keyboard and explains how it differs from a typewriter keyboard. It includes an exercise using the text editor, Edit.*

## **A tour of the keyboard**

Up to now we've concentrated on the mouse, and rather neglected the keyboard. If you're used to computers, you'll probably be able to find your way around it already. If you've used a typewriter, but not a computer, you'll recognise most of the keys, but there will be several which you won't have seen before.

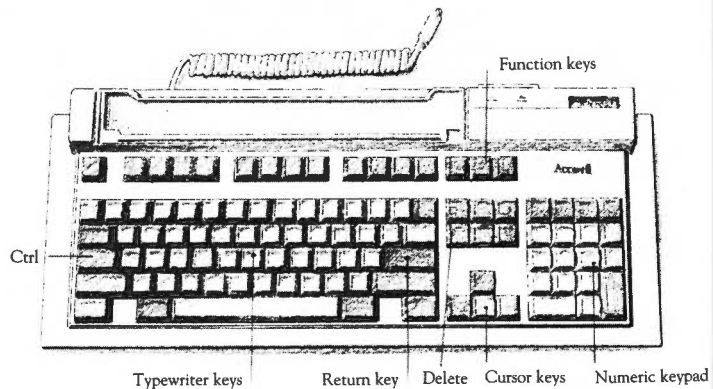

The keys are divided into blocks. The main block contains the keys similar to a typewriter keyboard. The Return key on the right completes a line, either starting a new line of text, or sending a name or instruction to the computer, depending on what you are doing.

Above the typewriter keys is a row of keys marked F1 to F12. These are function keys they can be programmed to perform a special function, depending on what software you are using at the time.

The function of these keys in a particular piece of software is usually marked on a keycard inserted in the clear window along the top of the keyboard. You don't need to use these keys at the moment.

At the far right is the numeric keypad, laid out like a calculator. These keys can be used either to type numbers or to perform special functions, depending on the program or application you are using.

The functions of the computer control keys often vary, depending on the software with which they are being used. Useful keys to know about at the moment are:

**Delete** - deletes a character to the left of the cursor.

**Ctrl** - (Control) when held down while another key is pressed, changes the meaning of that key (rather like Shift).

**Cursor keys** - moves the *cursor* (when it is visible) across the screen in the direction of the arrow.

You will need to use the keyboard for the following tasks:

- supplying answers to questions the computer asks in writable menu boxes (including giving names for files and documents you create)
- using a word-processor, or a text editor like Edit.

Whenever you need to use the keyboard within the Archimedes desktop, a vertical bar appears (it is red, if you have a colour monitor). This is called a *caret*. Any characters you type will appear to the left of the caret, which will move to the right.

The Applications suite contains a text editing program called Edit. This is represented on Applications disc 1 by a pen and a bottle of ink:



To use Edit:

- insert Applications disc 1 into the drive
- click on the floppy disc drive icon on the icon bar. Double click on the !Edit icon. Edit will be loaded, and its icon will appear on the icon bar.
- click on the Edit icon on the icon bar to create an Edit window. You can now begin typing.

## When to use the keyboard

## Practising using the keyboard

## Loading Edit

Anything you type appears in the window:

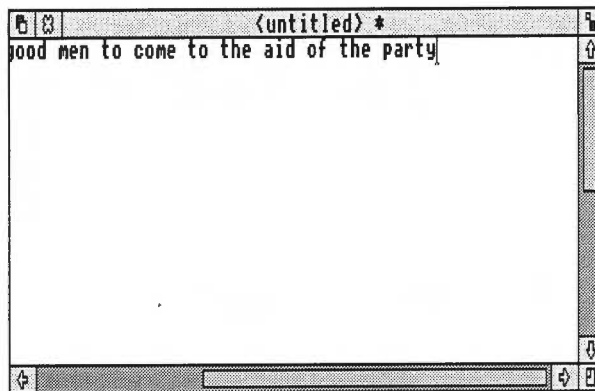

- The Caps Lock key light may be on when you start, indicating that all letters you type will be capitals. Press this to get all lower-case letters.
- Press the Shift key to type an upper-case letter or one of the upper characters on the number keys.

When you reach the end of the line the caret will go automatically to the start of the next line.

Press the Return key to force a new line, and press it again to leave a blank line. Experiment with the Shift, Caps Lock, Tab, Delete, Backspace and Return keys.

## Moving around your document

Once you have typed a few lines of text, move the caret around the text by moving the pointer with the mouse and clicking the select (LH) button - the caret will jump to the position of the pointer. Some other keys allow you to move around long documents:

**Page Up** moves to the previous page

**Home** moves the caret to the start of the document

**Page Down** moves to the next page

If you want to save the file you have created, and are using a non-write-protected *copy* of the Applications disc, see the procedure in *Files and Directories*.

## Leaving Edit

When you have finished practising using the keyboard, you can abandon your work and leave Edit:

- click on the close icon (top LH)
- click on the box marked No in the dialogue box.

The full capabilities of Edit are described in the *User Guide*.

# Files and directories

This chapter explains how information can be stored and moved around in the filing system, copied and deleted.

## About the filing system

Everything you create using the Archimedes computer can be saved as a *file*, whether it consists of text, graphics or a program. Each file has a name - you have to provide one when you save a new file.

Files are stored in *directories*. These directories can contain many files of different types, and also other directories.

Insert Applications disc 2, and click on the floppy disc icon. The *directory window* of the disc will be displayed. This contains various icons, including an icon which looks like a folder, called Modules. This is a directory. Double click on Modules, and the Modules directory window will appear on the screen. This contains other files, which are the different modules used by application programs.

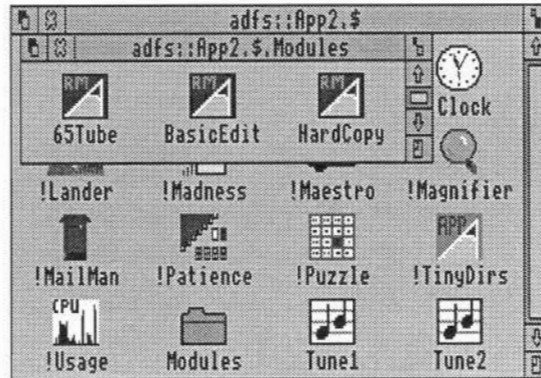

## Building a file structure

As you create more files, it will become increasingly important to file them carefully. If you leave all your files in the main directory on the disc, it will soon become large and unwieldy - you will have to scroll through the disc directory window every time you want to find something. Instead, build up a filing system with files of a similar type grouped in a directory. The filing system should have a structure something like this:

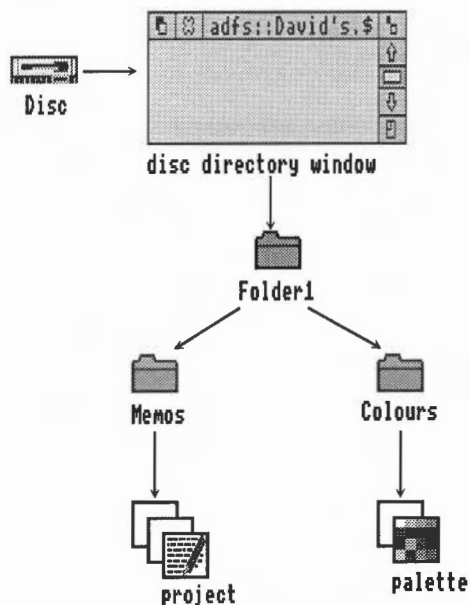

To do this, you will need to save files, create directories and copy files into them. These procedures are described on the following pages.

Note that in order to save a file you have created, for example in Edit, to the Applications disc, you will have to remove the *write-protection* from the disc (see *Disc Drives*). This is not advisable - it is much better to make a back-up copy of the disc, just in case you delete something by mistake. The chapter *The Advanced Disc Filing System* in the *User Guide* tells you how to make back-up copies.

## Saving (and loading) a file

1. Open the directory icon

Double click on the directory icon to open it. This is the directory you want to contain the file you are going to save.

*You could save your Edit file, created in the last chapter, to the directory window already open, if you are using a non-write-protected copy of the Applications disc (see the previous page).*

2. Select Save

Go back to the work you want to save, and select the Save option with the (centre) menu button.

3. Type in the file name

Type the name you want to give the file in the dialogue box. If there is a name already in the box (like Textfile here), which you don't want, erase it with the Delete key.

4. Drag the file icon into the directory window

Select the file icon in the dialogue box and drag it into the directory window.

The file can be loaded again by double-clicking on the file icon in the directory window.

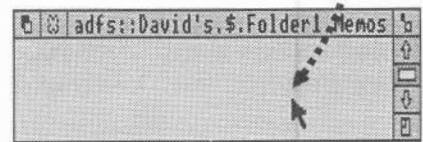
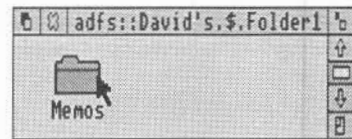



## Creating a new directory

1. Display the Filer menu
2. Select New directory
3. Type in the directory name
4. Click on the directory name

Click on the menu button in the directory window. (This is the directory in which you want the new directory to reside).

The Filer menu will appear.

Select the **New directory** dialogue box.

Type in the name you want to give the new directory.

Use the Delete key to erase mistakes.

Click on the new name to create the directory.

An icon for the new directory will appear in the first directory window.

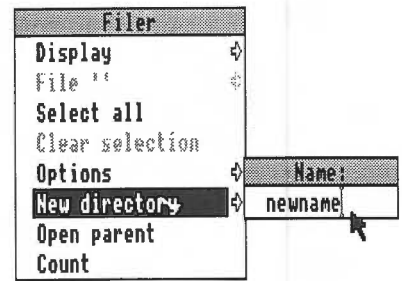

## Copying a file to a new directory

1. Select the icon to be copied.
2. Drag the icon to the new directory
3. Release the mouse button.

Point at the icon of the file or directory to be copied, and press the select (LH) button. The icon will be highlighted.

Drag the file or directory icon into the new directory window.

Release the mouse button and the file or directory will be copied into the new window. A copy of the icon will appear in the window when this has been done.

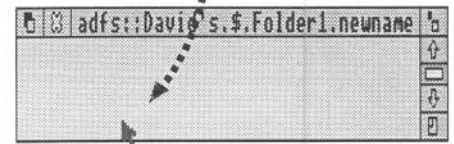
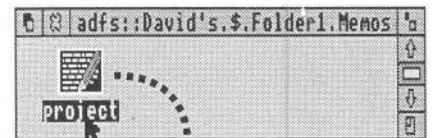

## Deleting files and directories

1. Select the file or directory to be deleted

Point at the icon, and press the select (LH) button. The icon will be highlighted:



2. Select the **File** or **Dir.** option in the Filer menu

Click the middle mouse button to display the Filer menu, and select the File or Dir. option.

A sub menu of options will be displayed, including **Delete**.

3. Click on **Delete**

The file and its icon will be deleted from the directory.

(If it hasn't been deleted, an error message may be displayed, indicating that the file has been locked against deletion. Select the Access option on the File menu to check this.)

To *move* a file to a new directory, copy it to the new directory, then delete the old copy.

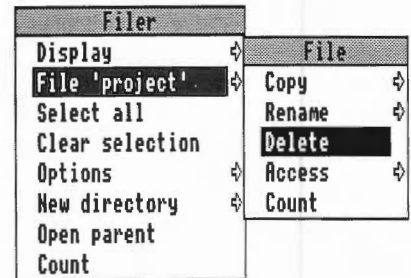



# Outside the desktop

This chapter is for more experienced users, describing how you can leave the desktop and address the operating system and languages, such as BASIC, directly.

## \* Commands

More experienced users will occasionally want to leave the Archimedes desktop environment, and issue commands direct to the operating system - \* commands. You do this by moving the pointer over the Archimedes 'A' icon at the far right of the icon bar and pressing the Menu (centre) button. Click on the \* Commands option. A line is cleared below the desktop, and the desktop moves up to make room for it. You will not lose any of your work on the desktop. The pointer disappears.

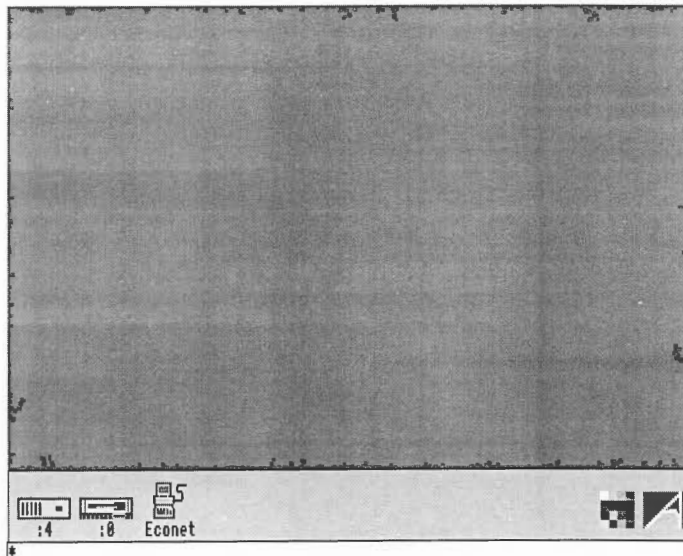

The star is a *prompt*. It means that the computer is ready for you to type text at the keyboard. The star prompt shows that you are talking to the computer's operating system and can enter \* commands. If you run a program or use a language, the prompt will change from a star to something else. You can run

programs or applications which are not accessible from the desktop from here, but you can't use any of the desktop features while you are using system commands, only the keyboard. The program or application you select, however, may use desktop features.

When you have finished, leave any program or application you have been using, and when the star prompt returns, press the Return key on the keyboard. This returns you to the desktop.

# If things go wrong

This chapter offers solutions to some problems you might encounter while you are finding your way around the desktop. If you try all the solutions suggested and the problem is not solved, consult your supplier.

## Problem

## Possible solution

No picture

The computer is turned on, but there is nothing on the screen.

Check that:

- the monitor is turned on
- the mains supply is connected
- the monitor is connected to the computer
- the brightness control on the monitor is not turned down too low.

Flickering or flashing display

The connectors between the monitor and the computer may be loose. Switch off both the computer and the monitor, and push in the connectors firmly (see *Setting up the computer*). If you are using a colour monitor, tighten the screws of the connector to the computer back panel with a small flat-bladed screwdriver.

Different screen display

The picture on your screen doesn't match that in the Guide.

Your icon bar may or may not include a hard disc icon, or an Econet icon, depending on whether you have either of these fitted. There may also be a RAM icon, if memory is allocated to the RAM filing system. If the display does not resemble the illustration at all, consult your supplier.

If the computer starts up with a different display, or other unexpected things occur while you are using it, you (or someone else) may have set up the system configuration (see *Configuration Commands* in the *User Guide*) in a different way. To restore the configuration to the default (as supplied when new), save any work you need, switch off the machine, then switch it on again *while holding down* the R key.

## Pointer won't move

Moving the mouse does not move the pointer.

Check that:

- the mouse is connected to the keyboard
- the keyboard is connected to the computer unit
- the surface you are moving the mouse across is firm enough to allow the ball in the base of the mouse to move. Move the ball with your fingers to check that the mouse works.

## Part of the display has become invisible

While you are adjusting the colours, the pointer, text, title bar or any other part of the display becomes invisible.

You have made two or more colour definitions identical, so the item is no longer distinguishable from its background. If possible, redefine one of the colours to bring back the contrast. If you can't see to do this, select Default palette from the palette icon menu, or reset the computer and start again. The original colours will be restored.

## An error message appears

A window appears on the screen reporting that you cannot do something you have attempted.

Error messages appear if you attempt something impossible, or if you try to use an application when there is not enough memory free. Click on the box marked OK or Cancel to go back to what you were doing before you made the error. The mistake will not have had any effect.

## Edit won't load

There is not enough memory to load Edit. If you have an Archimedes 305, you will not be able to run Edit at the same time as having a lot of other tasks running. You will have to remove some of the things that are already loaded into the computer's memory. Move the pointer over an icon in the icon bar and display its menu; select Quit to remove the application from the computer's memory. When you have removed some icons, there should be enough memory to run Edit.

## The desktop disappears

You have used the option Exit on the Task manager menu and exited from the desktop completely.

Type DESKTOP and press the Return key. The desktop will return, but you may have lost any unsaved work. Alternatively, hold down Ctrl and press the Reset button on the back of the keyboard to bring back the desktop.

# Glossary

You can't escape jargon when you use a computer, however hard you try - we've tried to chase most of it out of this Guide, but some remains. This chapter defines words which have evaded capture. Text appearing in italics is defined somewhere else in this Glossary.

Word	Definition
* commands	(Also called <i>operating system</i> commands.) Commands which allow you to perform tasks - such as writing or running a program - outside the environment of the <i>desktop</i> . You enter system commands in a special area displayed beneath the desktop from the task menu option '*Commands'. To leave the system commands and return to the desktop, finish any task or <i>application</i> , then press the RETURN key when you see the star prompt.
adjust button	Right hand <i>mouse</i> button, used to adjust items in the display.
adjust size icon	<i>Icon</i> in the bottom righthand corner of some <i>windows</i> allowing you to adjust the size of the window.
application	Computer program which provides a tool such as a word-processor or a drawing program.
back icon	<i>Icon</i> in the lefthand corner of the title bar of all <i>windows</i> which allows you to hide the window behind any other overlapping windows in the display.
click	Press and immediately release one of the <i>mouse</i> buttons.
close icon	Cross-shaped <i>icon</i> on the left of the title bar of all <i>windows</i> , next to the <i>back icon</i> . Clicking on the Close icon closes the window.
caret	Vertical bar indicating the position at which characters will appear in a text entry box or in an Edit <i>window</i> .
cursor	Usually a flashing underline, indicating the position at which characters will be entered on the screen.
default	The standard setting or option, which the computer uses, unless you tell it to do something else.



desktop	Area of the screen display in which <i>applications</i> can be run, <i>windows</i> opened and desk accessories can be used.
dialogue box	Area in some <i>windows</i> called up from <i>menus</i> asking you to type in text (such as the name for a <i>file</i> ).
directory	Storage area - like a folder - in which <i>files</i> can be kept. Each disc has a main directory, in which you can create further directories to build up a <i>filing system</i> to hold your files.
directory window	<i>Window</i> displaying the contents of a <i>disc</i> , <i>directory</i> or RAM.
disc	See <i>floppy disc</i> , <i>hard disc</i> .
document	A <i>file</i> .
double-click	Press and immediately release one of the <i>mouse</i> buttons twice in quick succession.
drag	Press one of the <i>mouse</i> buttons, keep it depressed while moving the mouse to drag the <i>pointer</i> across the screen, and then release the mouse button.
Econet	Acorn local area network. Information can be passed electronically between the computers on an Econet network.
file	A collection of information bundled together and given a name to identify it. It can be a letter written on a word-processor, a program, a palette definition, or some graphics.
filing system	Structure of <i>directories</i> and <i>files</i> analogous to an ordinary office filing system.
floppy disc	Removable disc for storing information for use with a computer. The Archimedes computer uses 3.5-inch floppy discs.
hard disc	<i>Disc</i> used for storing information for use by a computer. A hard disc unit (if fitted) is enclosed within the computer, it is not physically accessible and you cannot remove it. It has considerably greater storage capacity than a floppy disc, so only one hard disc is generally needed.
high resolution monitor	Archimedes 400 series computers may be used with a monochrome (black and white) high-resolution workstation <i>monitor</i> . As well as being bigger, the picture will be more sharply defined than on the standard-resolution monitor.

icon	Small picture representing <i>applications</i> , <i>files</i> , programs, tasks or items of hardware. <i>Clicking</i> or <i>double-clicking</i> on an icon selects or initiates a task or calls up an item.
icon bar	Strip along the lower edge of the <i>desktop</i> screen showing <i>icons</i> which represent the information storage facilities ( <i>discs</i> , <i>palette</i> , <i>Econet</i> ) and the <i>applications</i> currently accessible from the computer's <i>memory</i> .
memory	The computer's information storage areas (see also RAM and ROM). If you try to run too many tasks at once, you may run out of computer memory and have to remove some of the tasks you are not using.
menu	List of tasks or other options available. To call up a menu, click on the menu (centre) button on the <i>mouse</i> . To select a menu item, move the highlighting over the line you want to choose and press the select button.
menu button	Middle button on the <i>mouse</i> . Clicking it calls up a <i>menu</i> , if a menu is available. If no menu is available, clicking the menu button has no effect.
modem	Short for MOdulator-DEModulator. Device which allows one computer to communicate with another down a telephone line. Information is transmitted as a series of electronic signals which are interpreted by the computer receiving the information.
monitor	Screen unit (like a television set) used to display communications from the computer. A monitor may be monochrome (black and white) or colour. (Also called a visual display unit, or VDU.)
mouse	Rectangular box with three buttons and a cable attaching it to the keyboard. Moving the mouse causes a corresponding movement of the <i>pointer</i> on the screen. The mouse buttons are used to select, alter or move items in the display, or to call up <i>menus</i> .
operating system	The instructions used to communicate directly with the computer, behind the <i>desktop</i> , telling it to run <i>applications</i> or programs, and communicate with the screen, keyboard and peripherals.
palette	Window displaying blocks of colours and red, green and blue colour bars. It allows you to select the colours used for the screen display.
peripheral	Additional piece of equipment - such as a printer - which you may connect to the computer.

pointer	Arrow displayed on the desktop screen and used to indicate tasks or options required, and to move or adjust items in the display. The pointer moves when the <i>mouse</i> is moved.
prompt	A character on the screen, followed by a <i>cursor</i> , indicating that the computer is ready to accept a command from the keyboard. * is the prompt for the <i>operating system</i> , > the prompt for Basic.
RAM	Random Access Memory part of the computer information storage system which is accessible for storing or retrieving information without using <i>discs</i> . Information in the RAM is lost when the computer is turned off.
ROM	Read Only Memory - similar to RAM, but ROM goesn't go away when you switch the computer off. The <i>operating system</i> and BBC BASIC are permanently present in the Archimedes ROM.
scroll arrows	Arrows at either end of the <i>scroll bars</i> on <i>windows</i> which may not show a <i>file</i> in its entirety. If a complete file is not visible on the screen, clicking on the scroll arrows moves through it in small steps.
scroll bars	Shaded bars with sliders along the righthand edge and sometimes the lower edge of <i>windows</i> which may be too small to show a complete <i>file</i> . If the complete file isn't visible on the screen, <i>clicking</i> on or <i>dragging</i> the slider along the scroll bar adjusts the area of the file shown in the window.
select	Use the <i>mouse</i> to point at an <i>icon</i> , then <i>click</i> the <i>select button</i> on the mouse.
select button	Lefthand button on the <i>mouse</i> , used to select tasks or items in the <i>desktop</i> display, <i>icon bar</i> or <i>menus</i> , and to drag items in the display.
title bar	Bar along the top of a <i>window</i> in which the name of the window appears. The name will be the title of an <i>application</i> or desk accessory, or the name of <i>file</i> or <i>directory</i> you are using. If you are working on a new file, the title bar will report that it is untitled.
toggle	Click for ON, click again for OFF.
toggle size icon	<i>Icon</i> in the righthand corner of the title bar of some <i>windows</i> . <i>Clicking</i> on this icon toggles the window between its full size, and the size at which it was last displayed.

VDU

Visual Display Unit: *monitor* or screen on which communication with the computer is displayed.

window

Area of the screen designated for a particular activity or display - for example, an Edit window used to write a *file*, or a *directory* window used to display the contents of a *disc*. Windows can be moved, resized, hidden and closed. If a file is too large to display at once, you can move through it making different parts visible in the window using the *scroll arrows* and *scroll bars*.

Write-protect

To lock a floppy disc so that information on it cannot be changed, and new information cannot be saved to it. Discs are write-protected by moving the small square plastic tab towards the outside edge of the disc. See the chapter *Disc drives* for a fuller explanation.

